



INTEGRATED  
INFORMATION  
TECHNOLOGY INC

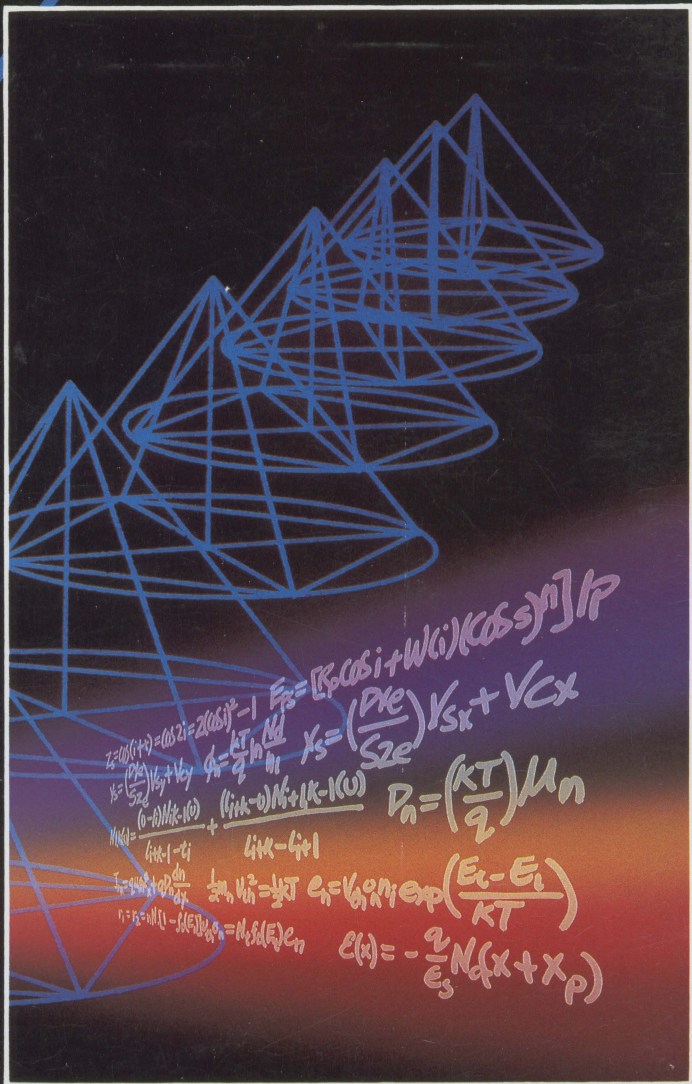
Advanced

# math

CoProcessor

## Installation Manual

IIT 2C87,  
3C87 &  
3C87SX





**Integrated Information Technology, Inc.**

**IIT-2C87, IIT-3C87 and IIT-3C87SX  
Advanced Math Coprocessor**

# **Installation Manual**

## **Trademarks**

The trademarks listed below and used in this manual are registered trademarks of the companies listed:

International Business Machines Corporation - IBM, AT and Personal System/2

Compaq Computer Corporation - Compaq, Compaq Deskpro 286, Compaq Portable II, and Compaq Portable III

Intel Corporation - Intel, Above and Inboard

Integrated Information Technology, Inc. - IIT

# **Table of Contents**

Preface .....	4
Contents of Kit .....	4
Application .....	5
Before Installing the Coprocessor .....	5
Installation Information and Requirements .....	6
Preparing the Computer .....	7
Installing the 2C87 Chip .....	8
Installing the 3C87 Chip .....	12
Installing the 3C87SX Chip .....	16
After Installing the Chip .....	17
Testing Procedures .....	18
Troubleshooting .....	19
Appendix A (Socket Locations) .....	21

## ***Preface***

This manual is provided to guide you in the installation of the Integrated Information Technology IIT-2C87 Math Coprocessor in your 80286 based computer, the IIT-3C87 Math Coprocessor in your 80386 based computer and the IIT-3C87SX Math Coprocessor in your 80386SX based computer.

## ***Contents of Kit***

Your IIT-2C87, IIT-3C87 or IIT-3C87SX kit contains the following items:

- IIT-2C87, IIT-3C87 or IIT-3C87SX 80-bit numeric coprocessor
- Demonstration/test program disk
- Installation Manual

## ***Applications***

You can install the IIT-2C87 coprocessor in any IBM PC AT or 100% compatible computer, including the following computers:

- IBM Personal System/2 Model 50
- IBM Personal System/2 Model 60
- COMPAQ DESKPRO 286 (8 MHz)
- COMPAQ DESKPRO 286 (12 MHz)
- COMPAQ PORTABLE 286 and II

You can install the IIT-3C87 coprocessor in any 80386-based computer, including the following computers:

- COMPAQ PORTABLE III
- INBOARD 386
- INBOARD 386/PC

The coprocessor socket locations for each of these computers are illustrated in Appendix A.

You can install the IIT-3C87SX coprocessor in any 80386SX-based computer.

## ***Before Installing the Coprocessor***

Follow the manufacturer's directions in your owner's manual to perform the following procedures:

- Removal and replacement of the computer's cover
- Removal and replacement of plug-in circuit boards and cables, if required to gain access to the coprocessor socket
- Switch settings and jumper installation, as required

# ***Installation Information and Requirements***

---

## **WARNING**

**Static electricity can destroy the coprocessor chip and other chips on your computer's circuit boards!**

---

## **Electrostatic Discharge (ESD) Handling Precautions**

The potential hazard of static electricity to the coprocessor and other circuit board components in your computer cannot be overemphasized.

Some tips to avoid the problem of static electricity are:

- Avoid handling the coprocessor chip out of its protective case, especially while standing on a carpet.
- Before handling the coprocessor, discharge yourself by touching a metallic part of the computer chassis or by wearing a static discharge device.
- If possible, stand on an antistatic floor pad or on a concrete floor.

## ***NOTE:***

*If you are replacing an existing coprocessor chip with an IIT coprocessor, use a puller specifically designed to remove the chip. If the old chip is still operational, you can use it in another computer that does not require the speed provided by the IIT coprocessor. Remember to handle these chips with care to avoid damage from static electricity.*



## ***Preparing the Computer***

1. Unplug the power cord and disconnect other device cables from the computer.
2. Place the computer on a suitable work surface where you will have freedom to remove the cover and install the coprocessor.
3. Remove the computer cover in accordance with the manufacturer's directions and place it aside.
4. Refer to your computer manual or to Appendix A to find the location of the coprocessor socket in your computer.
5. Make sure the speed of your IIT coprocessor is equal to, or greater than, the speed recommended for your computer.

### ***NOTE:***

*Your computer may require that you set a switch or install a jumper so that the computer will recognize the presence of the coprocessor. Refer to your owner's manual for directions.*

6. Discharge yourself from static electricity by touching an unpainted metal surface on the computer chassis. Unplug any circuit boards that must be removed to gain access to the coprocessor socket. Place the circuit boards in an electrostatically-safe location.

## **Installing the 2C87 Chip**

*NOTE: The IIT-2C87 is a rectangular 40-pin chip.*

1. Discharge yourself. Then, open the case which holds the coprocessor chip. If you have moved around (shuffled your feet, etc.) while opening the case, discharge yourself again and then carefully remove the coprocessor from the antistatic material in its case. When removing the chip, take care not to bend any of the pins.
2. Examine the coprocessor chip to identify the positioning notch. Note whether there are any bent pins.

**CAUTION:**

*The pins on an integrated circuit must be aligned with the corresponding holes in the socket into which it is to be inserted. The correct method of determining the direction for inserting the chip is to align the notch on one end of the chip with the corresponding notch on the socket. Installing an integrated circuit in the wrong direction is perhaps the most common of all installation errors. Improper installation can damage the coprocessor.*

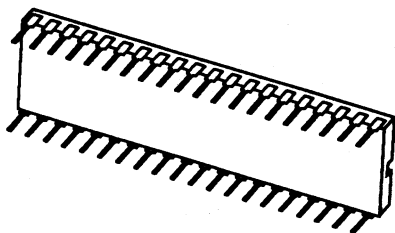
3. After referring to the following figures and procedures carefully insert the coprocessor into the socket

---

**WARNING:**

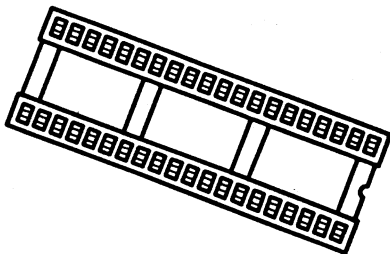
**Attempting to insert an integrated circuit with bent pins into a socket may result in further bending of the pins and even breakage. Bent pins should be straightened only with a pin straightening tool. Do not attempt to straighten bent pins with pliers, tweezers, fingers, etc.**

---



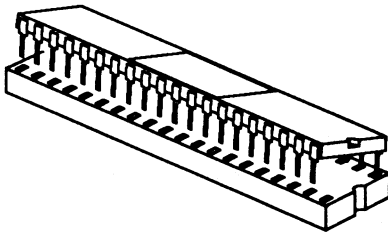
**FIGURE 1 — BOTTOM VIEW OF 40-PIN CHIP**

- Discharge yourself before handling and removing the chip from its case and antistatic material.
- Straighten any bent pins.



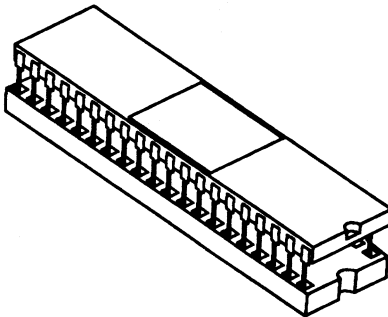
**FIGURE 2 — TYPICAL 40-PIN SOCKET**

- Some sockets may be solid and of different thicknesses.
- Note that only one end of the socket has a notch.



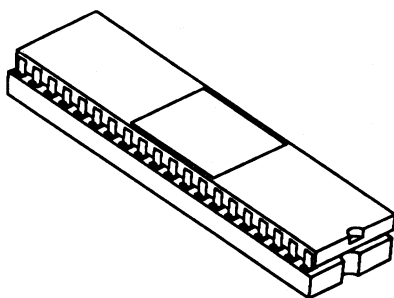
**FIGURE 3 — STARTING INSERTION**

- Align the pins on one side of the chip with the holes in the socket.
- Partially insert the pins on that side of the socket.
- With the pins on one side partially inserted, gently move the chip to also partially insert the pins on the other side.
- STOP! Visually check the pins on both sides to see that all pins are partially inserted into the holes.
- If any pins are bent inward or outward, carefully remove the chip and straighten the pins.
- Replace the chip in its antistatic material if you must put it down to get a straightening tool.
- If the chip was removed, REPEAT the previous steps.



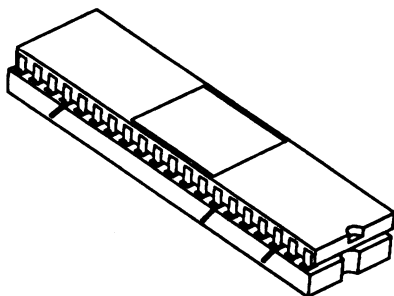
**FIGURE 4 — CHIP WITH PINS PARTIALLY INSERTED**

- With two fingers, apply even pressure to the chip so that both sides are fully inserted at the same time.
- STOP! Visually inspect the pins on both sides to make sure they are aligned with the holes.
- If pins are bent or not correctly aligned with the holes in the socket, remove the chip with a removal tool and straighten the pins.
- REPEAT all previous steps if the chip was removed.



**FIGURE 5 — CORRECTLY INSTALLED CHIP**

- Make sure that the notches on the coprocessor and the socket are aligned.



**FIGURE 6 — BENT PINS**

- Pins that are bent or crumpled outward are usually obvious.
- Pins that are bent inward are difficult to see. Use a magnifying glass to help with your inspection.

## ***Installing the 3C87 Chip***

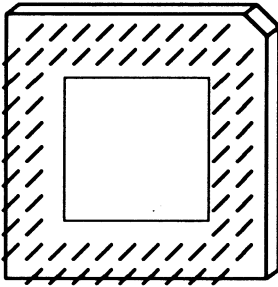
*NOTE: The IIT-3C87 is a square 68-pin (grid array) chip.*

1. Discharge yourself. Then, open the case which holds the coprocessor chip. If you have moved around (shuffled your feet, etc.) while opening the case, discharge yourself again and then carefully remove the coprocessor from the antistatic material in its case. When removing the chip, take care not to bend any of the pins.
2. Examine the coprocessor chip to identify the positioning bevel. Note whether there are any bent pins.

### ***CAUTION:***

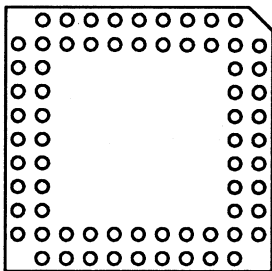
*The pins on an integrated circuit must be aligned with the corresponding holes in the socket into which it is to be inserted. The correct method of determining the direction for inserting the chip is to align the bevel on one corner of the chip with the corresponding notch or bevel on the socket. Installing an integrated circuit in the wrong direction is perhaps the most common of all installation errors. Improper installation can damage the coprocessor.*

3. After referring to the following figures and procedures carefully insert the coprocessor into the socket.



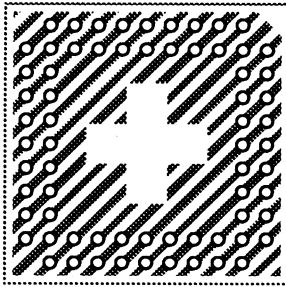
**FIGURE 7 — BOTTOM OF 68-PIN CHIP**

- Discharge yourself before handling and removing the chip from its case and antistatic materials.
- Straighten any bent pins.
- This style of chip can be inserted into its socket in four different directions. Only one of these directions is correct.
- Note the bevel on one corner of the chip. This bevel must be aligned with the corresponding bevel or alignment mark on the socket.



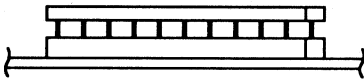
**FIGURE 8 — HOLE SIDE of NOTCHED 68-PIN SOCKET**

- One corner of this style of socket has been notched or beveled.
- The bevel on the chip must be aligned with the notch or bevel on the socket for correct installation.



**FIGURE 9 — HOLE SIDE OF A MARKED 68-PIN SOCKET**

- This style of socket may have the alignment mark either painted or etched around the top of the socket.
- The alignment mark on the illustration (fig. 9), just as on an actual socket, may be difficult to see.

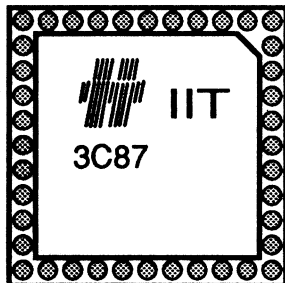
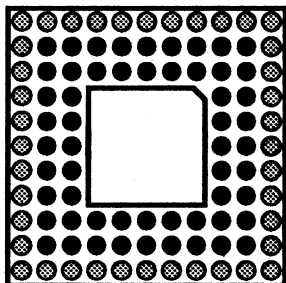
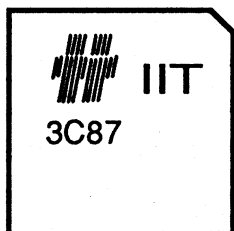


**FIGURE 10 — CHIP WITH PINS PARTIALLY INSERTED**

- All the pins on the 68-pin chip must be inserted at the same time.
- Align the bevel on the chip with the bevel or alignment mark on the socket.
- Align the pins on the chip with the holes in the socket.
- Gently and evenly, press the chip with two fingers until the pins are partially inserted.
- STOP! Visually check the pins on all sides to make sure that all pins are partially inserted into the holes.



- With two fingers, apply even pressure to the chip so that all sides are fully inserted at the same time.
- **STOP!** Check again to verify that the notches or bevels are aligned. If not, remove the chip with a removal tool and **REPEAT** all previous steps.
- If the chip is fully inserted into the socket and the notches or bevels are aligned, installation of the chip is complete.



**FIGURE 11 — CHIP AND ALTERNATE SOCKET**

- The 68-pin chip also fits into the socket shown in figure 11.
- Make sure to insert the pins into the inner two rows of holes in the socket.

4. Examine the installed coprocessor to make sure that:
  - The bevels on the chip and socket are aligned
  - The pins are properly aligned
  - The pins are not bent

## ***Installing the 3C87SX Chip***

### **NOTE:**

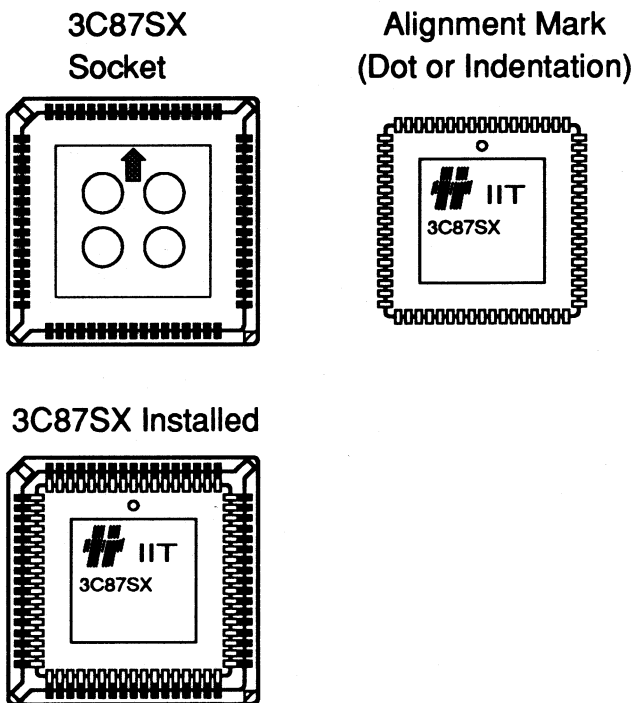
*The IIT-3C87SX is assembled in either a square 68-pin leaded chip carrier (LDCC) or plastic leaded chip carrier (PLCC). Both ceramic (LDCC) and plastic (PLCC) chip packages are marked with a dot. Plastic packages are also marked with a bevel on the upper left corner.*

1. Discharge yourself. Then, open the case which holds the coprocessor chip. If you have moved around (shuffled your feet, etc.) while opening the case, discharge yourself again and then carefully remove the coprocessor from the antistatic material in its case.
2. Locate the math coprocessor socket on the PC system board. The top of the socket will be indicated by the chip alignment mark. The chip alignment mark will be either an arrow head, a dot or a triangle in the socket.

### **NOTE:**

*The leads on an integrated circuit must be aligned with the corresponding contacts in the socket into which it is to be inserted. Improper installation can damage the coprocessor.*

3. The alignment mark on the 3C87SX chip is a small dot or indentation located near the top edge of the chip. Match this dot or indentation with the alignment mark in the socket.
4. Place the 3C87SX chip on the socket with the IIT logo and part number facing up. Align the leads with socket. Press evenly on the chip until it seats firmly in the socket.



**FIGURE 12 — TOP VIEW OF CHIP AND SOCKET**

## ***After Installing the Chip***

1. After making sure that the chip is installed correctly, replace all circuit boards and cables that were removed. Be sure to discharge yourself before handling the boards.
2. Replace the cover, cables and power cord following the procedures in the owner's manual for your computer.
3. Position the computer in a normal operating position and plug in the power cord.
4. Turn on your computer and proceed to the next section for information on how to test the coprocessor.

## ***Testing Procedures***

Integrated Information Technology wants you to see the power of your new coprocessor. The demonstration/test program disk provided with your IIT-2C87, IIT-3C87 or IIT-3C87SX coprocessor demonstrates graphically the superior performance of your computer when the IIT coprocessor Test Program is installed.

To test the coprocessor, turn the computer on and perform the following:

- Boot your DOS program.
- Make drive A or B the default drive by typing "A:" or "B:" and then pressing the ENTER key.
- Insert the demonstration/test disk into the selected drive.
- Type "IIT" and then press the [ENTER] key.

The test for recognition and operation of the coprocessor is performed automatically. If the coprocessor has been installed correctly, a status screen will be displayed. The screen indicates the presence of the IIT coprocessor and other features of your computer. If the status screen does not appear, turn off the computer immediately and refer to the troubleshooting information in this section.

You can run the benchmark program from the floppy disk by pressing the [ENTER] key after you have reviewed the status screen. However, if you want the shortest extension time, run the program on a RAM (or VDISK) or on a hard disk drive.

To run the benchmark program from a RAM (or VDISK) or hard disk drive, refer to the "READ ME" file on the disk.

# ***Troubleshooting***

Incorrect installation and failure to follow start-up procedures can cause your computer and coprocessor to malfunction.

Refer to the following list of symptoms and possible solutions to identify the problem:

## **SYMPTOM:**

The computer does not power on or the operating system prompt does not appear on the screen.

## **POSSIBLE CAUSES:**

- Power cord and other cables are not plugged in or attached correctly.
- Circuit boards removed were not replaced or installed incorrectly.
- The coprocessor is not installed correctly or was damaged during installation.

## **SYMPTOM:**

Coprocessor installation is not recognized by computer.

## **POSSIBLE CAUSES:**

- Switches on the circuit board have not been set in the correct position, or the jumpers have not been installed correctly.
- Software configuration program has not been performed.
- Manufacturer installed the coprocessor socket in the wrong direction.

## **NOTE:**

The program on the demonstration/test disk provided with your IIT coprocessor will function even if you have not yet configured your computer to incorporate the coprocessor.

**NOTE:**

If your computer requires configuration, it must be performed before the coprocessor will operate with your programs.

**SYMPTOM:**

Coprocessor is recognized by the computer but programs do not seem to run any faster.

**POSSIBLE CAUSES:**

- The application program being used does not use or has limited use of floating point mathematics. Check the manual for your application program to determine if it can utilize a coprocessor.

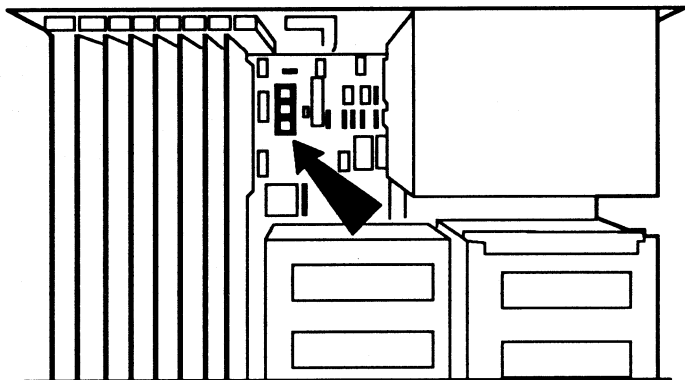
**SYMPTOM:**

The demonstration/test program does not operate.

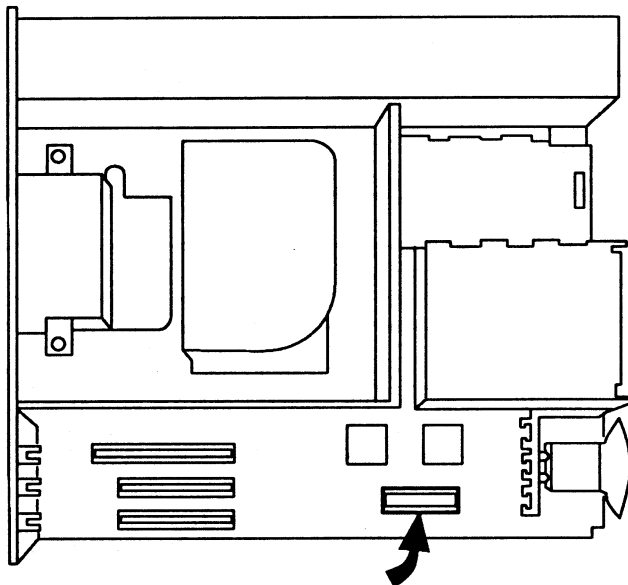
**POSSIBLE CAUSES:**

- The coprocessor is installed incorrectly or was damaged during installation.
- Where applicable, control switches are not in the correct position or the jumpers are not installed correctly.

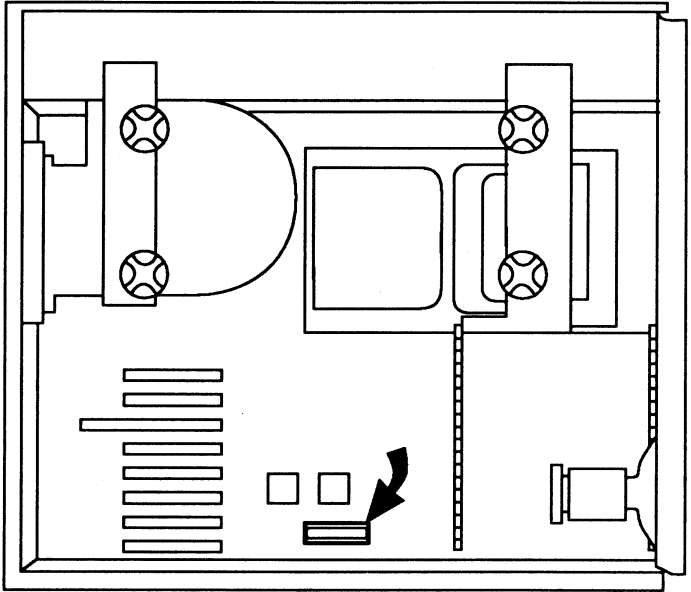
# APPENDIX A: SOCKET LOCATIONS



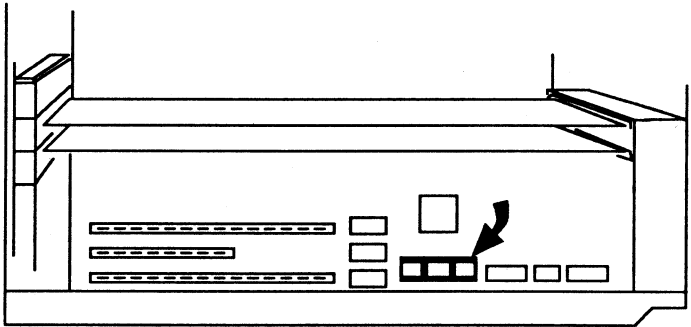
**FIGURE A-1 IBM PC AT**



**FIGURE A-2 IBM PERSONAL SYSTEM/2 MODEL 50**

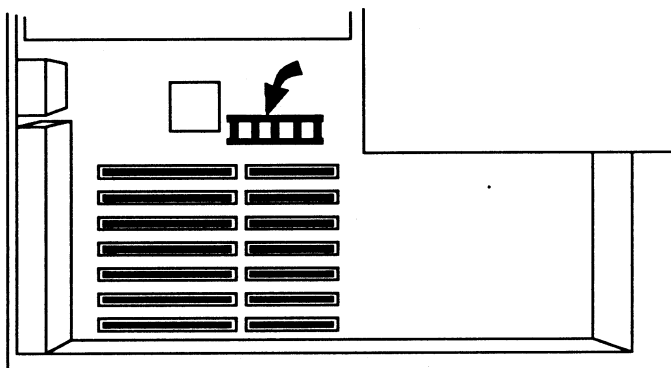


**FIGURE A-3 IBM PERSONAL SYSTEM/2 MODEL 60**

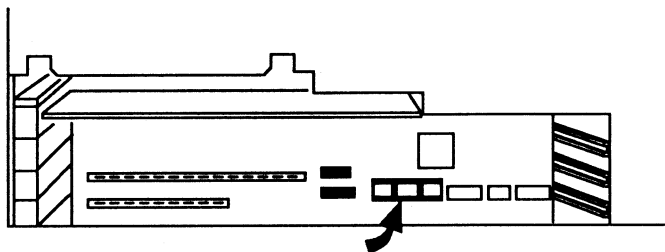


**FIGURE A-4 COMPAQ DESKPRO 286 (8 MHZ)**

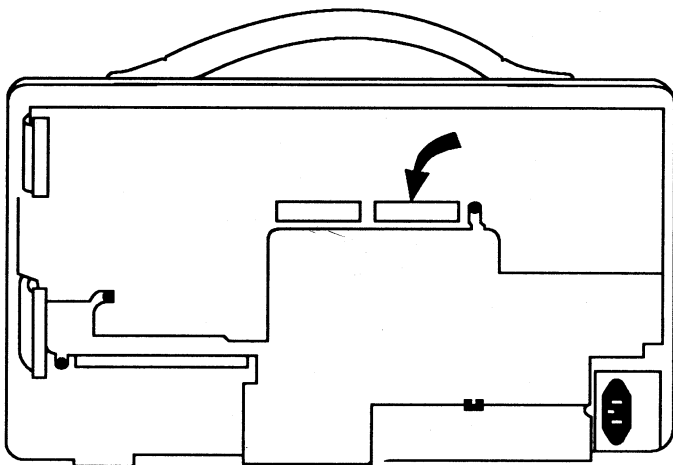




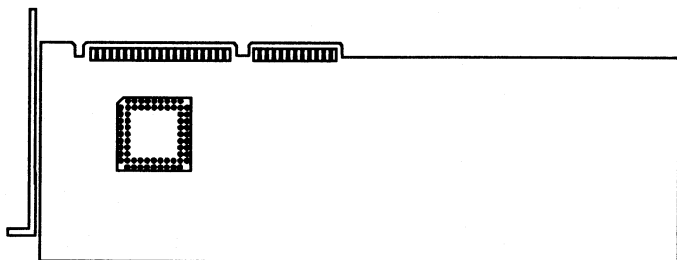
**FIGURE A-5 COMPAQ DESKPRO 286 (12 MHZ)**



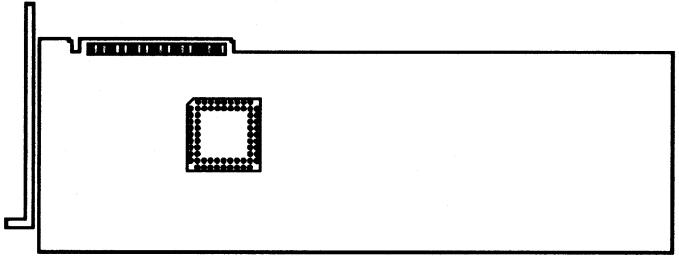
**FIGURE A-6 COMPAQ PORTABLE 286 & II**



**FIGURE A-7 COMPAQ PORTABLE III**



**FIGURE A-8 INBOARD 386**



**FIGURE A-9 INBOARD 386/PC**

## **LIFETIME LIMITED WARRANTY**

Integrated Information Technology, Inc. (IIT) warrants this component to be in working order for the lifetime of the personal computer in which the component is initially installed from the date you purchased it from your authorized IIT dealer. If the component fails to be in working order during the lifetime of the personal computer, IIT will, at its option, repair, replace or refund at no charge as set forth below.

IIT furnishes warranty service on an exchange basis. IIT will repair or replace your component with a new or reconditioned component. Any replaced components become the property of IIT. This warranty does not cover repair, replacement or refund for components damaged by abuse, accident, disaster, misuse or incorrect installation.

To obtain warranty service the component must be returned along with proof of purchase date to the dealer from whom you bought it. If you choose to ship the component to your dealer, you must assume the risk of damage or loss in transit. You must also use the original shipping container (or the equivalent) and pay the shipping charges.

**EXCEPT FOR THE EXPRESS WARRANTIES PROVIDED IN THIS PARAGRAPH ENTITLED "LIFETIME LIMITED WARRANTY", ALL WARRANTIES, WHETHER EXPRESS OR IMPLIED, ALL GUARANTEED AND ALL REPRESENTATIONS AS TO PERFORMANCE, INCLUDING ALL WARRANTIES WHICH, BUT FOR THIS PROVISION, MIGHT ARISE FROM THE COURSE OF DEALING OR CUSTOM OF TRADE AND INCLUDING ALL IMPLIED WARRANTIES OF MERCHANTABILITY OR FITNESS FOR A PARTICULAR PURPOSE, WITH RESPECT TO THE PRODUCTS FURNISHED BY SELLER HEREUNDER ARE HEREBY EXPRESSLY EXCLUDED AND DISCLAIMED BY SELLER.**

**ALL WARRANTIES SET FORTH IN THIS WARRANTY ARE LIMITED TO THE LIFETIME OF THE PERSONAL COMPUTER IN WHICH THE COMPONENT IS INITIALLY INSTALLED.**

**IF THIS COMPONENT IS NOT IN WORKING ORDER, YOUR ONLY REMEDY IS REPAIR OR REPLACEMENT AS DESCRIBED ABOVE. UNDER NO CIRCUMSTANCES WILL IIT BE LIABLE FOR CONSEQUENTIAL DAMAGES, INCLUDING ANY LOST SAVINGS, LOST PROFITS, OR ANY OTHER DAMAGES CAUSED BY THE USE OF THIS COMPONENT OR INABILITY TO USE IT, EVEN IF THE DEALER OF IIT HAS BEEN ADVISED OF SUCH LIABILITY OR OTHER CLAIMS.**

**SOME STATES PROHIBIT EXCLUSION OR LIMITATIONS OF DAMAGES FOR CONSUMER PRODUCTS. IF YOU LIVE IN ONE OF THESE STATES, THESE LIMITATIONS MAY NOT APPLY TO YOU.**

**NOTE: THIS WARRANTY COVERS COMPONENTS ONLY AS DELIVERED BY IIT. IF YOU DAMAGE THE COMPONENT OR THE UNIT IN WHICH THE COMPONENT IS TO BE USED WHILE INSTALLING IT, THIS WARRANTY DOES NOT COVER REPAIR, REPLACEMENT OR REFUND. IIT RECOMMENDS THAT YOU HAVE YOUR AUTHORIZED IIT DEALER INSTALL THIS COMPONENT.**



W A R R A N T Y S E R V I C E

Note that it is not necessary to return this card to invoke your warranty. It is important to retain a copy of your original purchase receipt in the event warranty service is required. Your part is warranted for the lifetime of the personal computer which the component is initially installed from the date of purchase. (Warranty information is provided in the back of the installation manual.) Simply bring the part and the original purchase receipt to the place of purchase.

We would appreciate your comments on the IIT Coprocessor that you have purchased. Please take a moment to fill out this card after you have used the IIT Coprocessor for awhile.

Part Number

IIT-2C87-\_\_\_\_\_ IIT-3C87-\_\_\_\_\_ IIT-3C87SX-\_\_\_\_\_

Your Name \_\_\_\_\_

Your Title \_\_\_\_\_

Company \_\_\_\_\_

Address \_\_\_\_\_

Country \_\_\_\_\_

Phone \_\_\_\_\_

What operating systems are in your workplace?

DOS \_\_\_\_\_ UNIX \_\_\_\_\_ O/S2 \_\_\_\_\_ Other \_\_\_\_\_

What brands of software do you use? \_\_\_\_\_

Data Base \_\_\_\_\_ Scientific \_\_\_\_\_

Spreadsheet \_\_\_\_\_ Publishing \_\_\_\_\_

Engineering \_\_\_\_\_ CAD Package \_\_\_\_\_

Where did you purchase the IIT Coprocessor? \_\_\_\_\_

\_\_\_\_\_

What is your application for the Coprocessor? \_\_\_\_\_

\_\_\_\_\_

Please send Technical Specification and Application Notes for 4 x 4.

Comments: \_\_\_\_\_

\_\_\_\_\_



INTEGRATED  
INFORMATION  
T E C H N O L O G Y • I N C

Place  
Postage  
Here

Attn: Customer Service  
Integrated Information Technology, Inc.  
2445 Mission College Boulevard  
Santa Clara, CA 95054



INTEGRATED  
INFORMATION  
TECHNOLOGY, INC.

©Integrated Information Technology, Inc., 1990  
All rights reserved.  
Printed in U.S.A. 40M 10/90